

# SOUNDPRO USER GUIDE

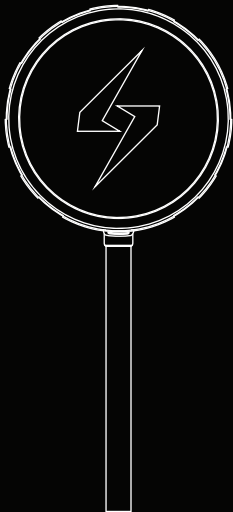
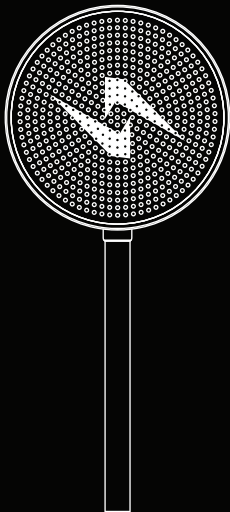

## MULTI-FUNCTION BUTTON

●  
1X PRESS  
PAUSE/PLAY  
ANSWER/END

● ●  
2X PRESS  
ACTIVATE  
ASSISTANT

▬  
LONG PRESS  
POWER ON  
POWER OFF

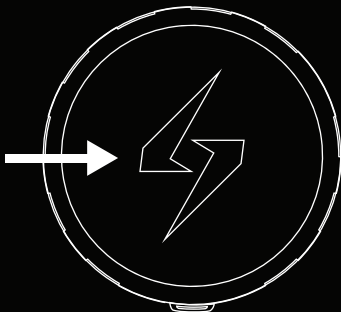

# PAIR NEW DEVICE "SOUNDPRO"



  
LONG PRESS  
TO BEGIN PAIRING

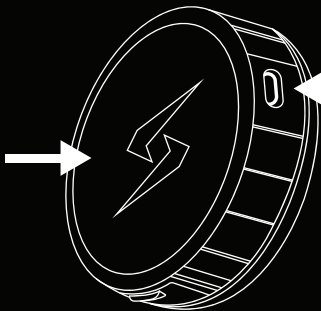

BLINKING LIGHT  
= PAIRING MODE

SOLID LIGHT  
= PAIRED

VOLUME UP

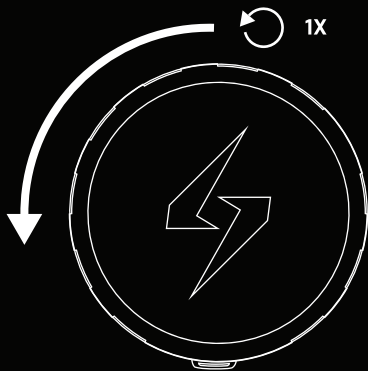

VOLUME DOWN

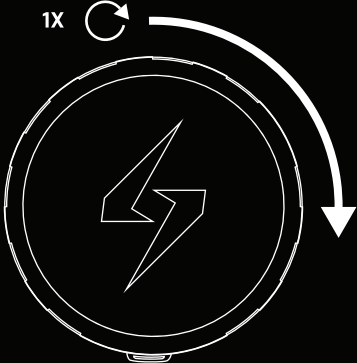

TRACK FORWARD

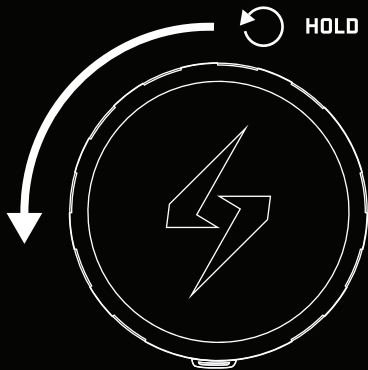

TRACK BACK

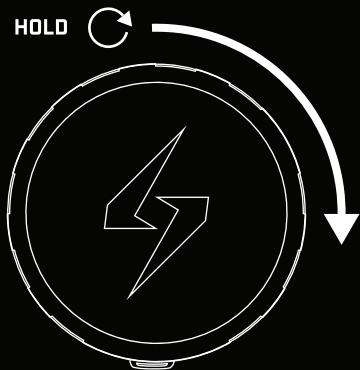

# RAPID CHARGE

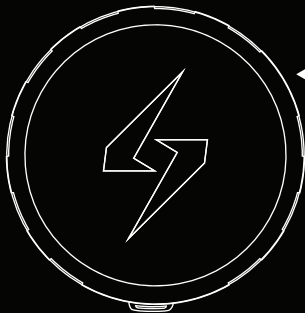

RED LIGHT  
= CHARGING

GREEN LIGHT  
= CHARGED



10 MIN CHARGE = 2 HRS PLAYTIME

USB-C  
CHARGING CABLE





## RECOMMENDED SPEAKER PLACEMENT

We recommend inserting the speakers behind the helmet liner and placing them in the left and right ear pockets directly over the ears with the Bluetooth controller on the wearer's left side. Begin by feeding the right (R) speaker (longest lead from the splitter) through the wearer's left ear pocket, behind the liner. Continue until the right (R) speaker reaches the wearer's right ear pocket. Leave any excess wire behind the liner. Place the left (L) speaker (shortest lead from the splitter) in the left ear pocket.

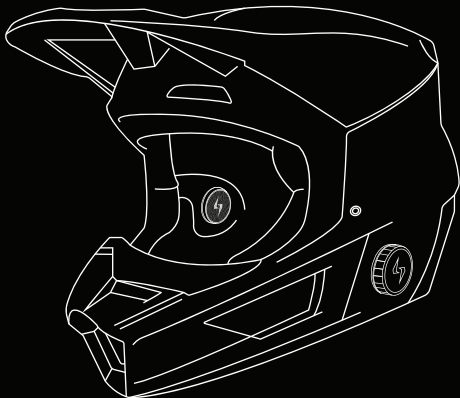

## SPEAKER VELCRO

Your speakers will stay in place with ultra-thin velcro. After determining where to place the speakers in the ear pockets, attach the velcro ring to the back of your speakers, and attach the velcro circle (soft side) in the ear pockets. After the velcro has been attached, secure the speakers in the ear pockets.

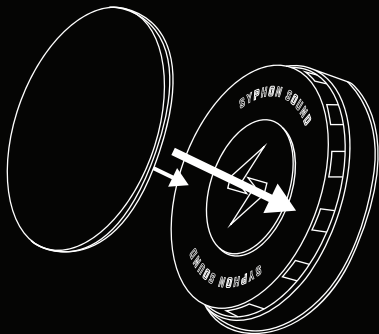

## SPEAKER SPACER (OPTIONAL)

The SoundPro speakers are loudest and sound best when they are as close to your ears as possible. After the velcro circles (soft side) have been placed in the ear pockets and the velcro rings have been attached to the back of your speakers, the spacers can be used to close any remaining gap between the speakers and your ears for a more customized experience.

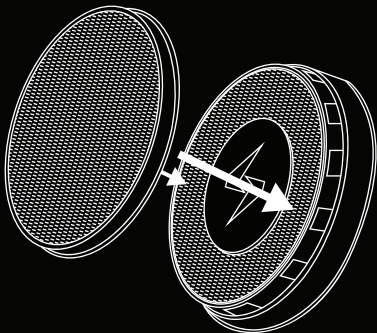

## SPEAKER FOAM COVER [OPTIONAL]

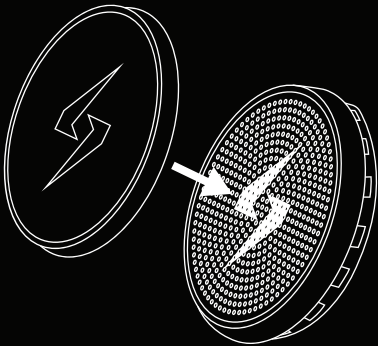

## SMARTWATCH INTEGRATION

With the right smartwatch you can leave your phone behind while riding. Just sync music to your smartwatch and pair "SoundPro." Use your smartwatch user manual for instructions on how to pair a Bluetooth device.

APPLE

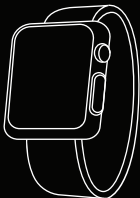

SAMSUNG

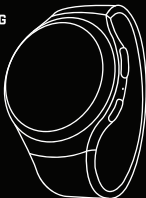

ANDROID

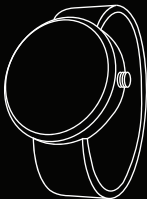

GARMIN

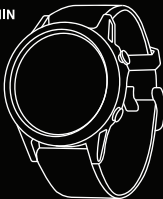

## DUAL LOCK (RECOMMENDED)

If you desire to secure the Bluetooth controller to your helmet, use the included dual lock. One sticky side goes on the back of the Bluetooth controller. The other sticky side goes on your helmet.

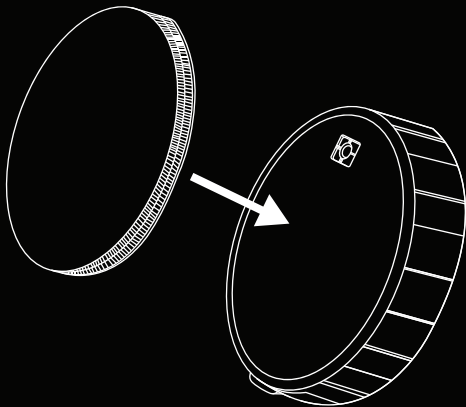

## RECOMMENDED CONTROLLER PLACEMENT

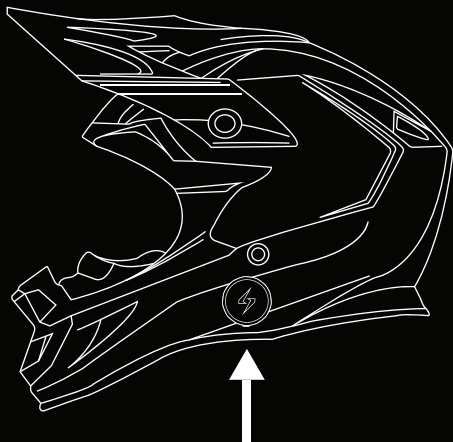

## CLIP ATTACHMENT (OPTIONAL)

If you do not wish to secure the Bluetooth controller to your helmet, screw in the included clip to the back of the Bluetooth controller with the included Allen wrench.

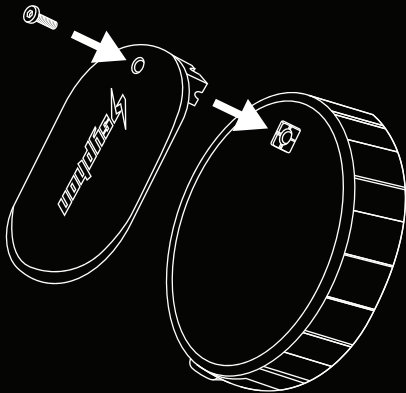



## OPTIONAL CONTROLLER PLACEMENT WITH CLIP

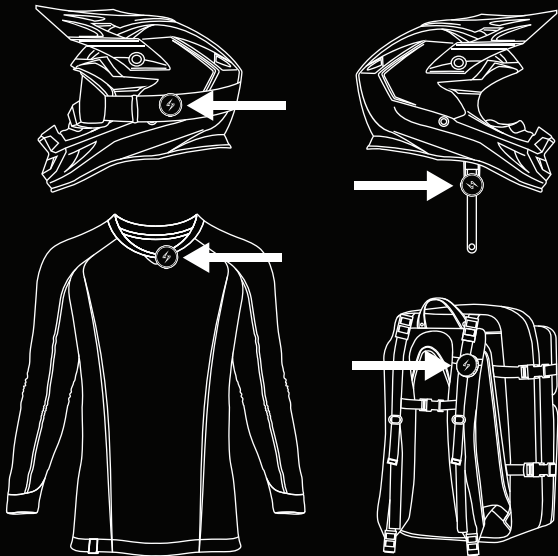

## PUSH-TO-TALK COMPATIBILITY

With the right walkie-talkie app (such as Discord or Zello), you can push-to-talk (PTT) chat with multiple riders with unlimited range as long as data reception is available. To use the PTT function, join the desired group on your preferred walkie-talkie app, and then press the designated “PTT” button (setup varies depending on which app you use and what phone you have). Follow the app’s user guide for instructions on how to use the PTT function and how to customize it to your preference.

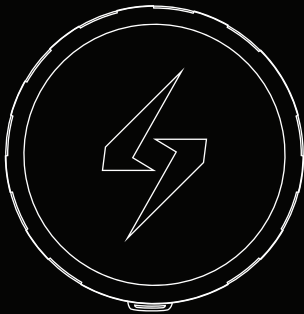

## PACKAGING CONTENTS

1x SoundPro  
1x Pair of Foam Speaker Covers  
1x Pair of Dual Lock + 1 Extra  
2x Pairs of Speaker Velcro  
1x Pair of Speaker Spacers  
1x USB-C Charging Cable  
1x Syphon Sticker  
1x SoundPro Clip  
1x Allen Wrench  
1x User Guide  
1x Storage Bag  
1x Excess Cable Fastener

## SPECIFICATIONS

Bluetooth 5.0  
Playtime: 10 hours  
Charge Time: 2 hours  
Sensitivity: -95dBm/+2dBm  
Response: 20Hz to 20KHz  
40mm Drivers  
9.8mm x 43.2mm Speaker Chassis  
17.9mm x 43.5mm Bluetooth Receiver  
Microphone: Built-in Microphone  
Battery: 250 mAh  
Waterproof: IPX5  
Weight: 62 Grams

## 1 YEAR GLOBAL WARRANTY

Syphon branded products will be free of defects in materials and workmanship and will not fail under normal usage for one (1) year from the date of purchase. Syphon's warranty does not cover damage caused by accidents or unauthorized modifications.

Syphon's warranty policy applies to all products purchased from syphonsound.com or any authorized Syphon retailer. To ensure that you are getting a genuine and new product that is covered by Syphon's warranty, always be sure that you are purchasing products from an authorized Syphon retailer. If you have questions about who is and isn't authorized to sell Syphon products, feel free to contact us. We're always happy to help.

Undamaged products in their original packaging may be returned for a full refund for any reason within thirty (30) days of purchasing. Once the returned item arrives back in Syphon's warehouse for inspection, the refund process will begin.

### **WATERPROOF**

Your SoundPro features an IPX5 waterproof rating. The SoundPro is designed to handle rain, mud, snow, and outdoor adventures.

## LISTEN RESPONSIBLY

The SoundPro gets loud. Very loud, 115+ dB to be exact. That's like being front and center at a Metallica concert, but in your helmet. Just because you *can* crank it up all the way doesn't mean you always *should*. Avoid excessive volume levels for prolonged periods of listening. Prolonged listening at excessive volume levels may cause permanent hearing loss.

### WARNING

Listening to music while riding something fast (motorcycle, dirtbike, snowmobile, atv, ski, snowboard, mountain bike, bmx, etc.) can be dangerous. Listening to music while using the SoundPro could reduce situational awareness. Personally, we think it could also increase situational awareness—but this paragraph is for the lawyers. By using the SoundPro you agree that you are taking this risk on your own accord.

## CARE AND MAINTENANCE

Turn the SoundPro off before cleaning and make sure the charge port is sealed. To clean the SoundPro, gently wipe away any dust with a dry cloth, and/or a slightly damp soft cloth to remove buildup. Never use corrosive detergents, wire brushes, abrasive scourers, metal, or sharp utensils to clean the SoundPro. During cleaning do not immerse any parts of the SoundPro in water or other liquids. Never hold the SoundPro under running water. Before charging, ensure the SoundPro is completely dry of water.

### STORAGE

Store the SoundPro in a dry area and avoid extreme temperatures. Keep away from children and pets.

## STILL NEED HELP?

Scan the QR code below or visit [syphonsound.com](https://syphonsound.com) for additional video resources with step-by-step instructions on setting up your SoundPro. Hit us up on our socials [@syphonsound](https://twitter.com/syphonsound) or shoot us a message over at [support@syphonsound.com](mailto:support@syphonsound.com) with any questions.



